



Norms: EN 60598-1, EN 60598-2-1



PRODUCT DESCRIPTION

Areas of Application: Commercial and Business areas, Public buildings, Offices, Schools, Corridors.

Mounting: Surface/Suspended.

Light Distribution: Direct.

Control Gear: Electronic equipment, 220-240VAC-50/60Hz.

Materials: Body: Extruded aluminium profile.

Surface Finish: Powder coated in white matt (RAL9016).

PB - Polished double parabolic louvre (middle)



LAMP*	UGR	W	Lm/W	η(%)	AxBxC (mm)	A1 (mm)	K1	K3	Kg	HF	DSI	DALI
T5	≤19	1x28	67	78	1171x204x55	1226	-	-	4	9R2M.128.81.A4	9R2M.128.81.84	9R2M.128.81.74
	≤19	1x35	83	83	1471x204x55	1526	-	-	4,5	9R2M.135.81.A4	9R2M.135.81.84	9R2M.135.81.74
	≤19	1x49	63	77	1471x204x55	1526	-	-	4,5	9R2M.149.81.A4	9R2M.149.81.84	9R2M.149.81.74
	≤19	1x54	60	77	1171x204x55	1226	-	-	4	9R2M.154.81.A4	9R2M.154.81.84	9R2M.154.81.74
	≤19	1x80	61	84	1471x204x55	1526	-	-	4,5	9R2M.180.81.A4	9R2M.180.81.84	9R2M.180.81.74
	≤16	2x28	68	79	1171x381x55	1226	•	•	5,5	9R2M.228.81.A4	9R2M.228.81.84	9R2M.228.81.74
	≤16	2x35	70	80	1471x381x55	1526	•	•	6,5	9R2M.235.81.A4	9R2M.235.81.84	9R2M.235.81.74
	≤19	2x49	64	79	1471x381x55	1526	•	•	6,5	9R2M.249.81.A4	9R2M.249.81.84	9R2M.249.81.74
	≤19	2x54	62	79	1171x381x55	1226	•	•	5,5	9R2M.254.81.A4	9R2M.254.81.84	9R2M.254.81.74
	≤19	2x80	55	77	1471x381x55	1526	•	•	6,5	9R2M.280.81.A4	9R2M.280.81.84	9R2M.280.81.74

Add suffix to order: Start - 0000.000.00.00.0067 End - 0000.000.00.00.0070

PM - Satin double parabolic louvre (middle)

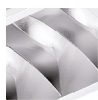

LAMP*	UGR	W	Lm/W	η(%)	AxBxC (mm)	A1 (mm)	K1	K3	Kg	HF	DSI	DALI
T5	≤16	1x28	56	66	1171x204x55	1226	-	-	4	9R2M.128.95.A4	9R2M.128.95.84	9R2M.128.95.74
	≤16	1x35	61	70	1471x204x55	1526	-	-	4,5	9R2M.135.95.A4	9R2M.135.95.84	9R2M.135.95.74
	≤19	1x49	55	66	1471x204x55	1526	-	-	4,5	9R2M.149.95.A4	9R2M.149.95.84	9R2M.149.95.74
	≤19	1x54	49	62	1171x204x55	1226	-	-	4	9R2M.154.95.A4	9R2M.154.95.84	9R2M.154.95.74
	≤19	1x80	51	71	1471x204x55	1526	-	-	4,5	9R2M.180.95.A4	9R2M.180.95.84	9R2M.180.95.74
	≤16	2x28	57	66	1171x381x55	1226	•	•	5,5	9R2M.228.95.A4	9R2M.228.95.84	9R2M.228.95.74
	≤16	2x35	59	68	1471x381x55	1526	•	•	6,5	9R2M.235.95.A4	9R2M.235.95.84	9R2M.235.95.74
	≤16	2x49	55	67	1471x381x55	1526	•	•	6,5	9R2M.249.95.A4	9R2M.249.95.84	9R2M.249.95.74
	≤19	2x54	52	66	1171x381x55	1226	•	•	5,5	9R2M.254.95.A4	9R2M.254.95.84	9R2M.254.95.74
	≤19	2x80	48	67	1471x381x55	1526	•	•	6,5	9R2M.280.95.A4	9R2M.280.95.84	9R2M.280.95.74

Add suffix to order: Start - 0000.000.00.00.0067 End - 0000.000.00.00.0070

*Lamp not included.

Example code for order: 9R2M.135.81.74.0067 (START) + (6x) 9R2M.135.81.74 (MIDDLE) + 9R2M.135.81.74.0070 (END) + (7x) 9465 + (8x) 910003 + D/I (OPTIONS)

We reserve the right to make technical changes without prior notice.
Electrical/Optical data are subjected to a tolerance of +/-10%.

OPTIONS

Through-wiring

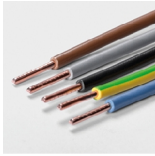

1,5 mm² through-wiring
3 x 1,5 mm²
5 x 1,5 mm²
2,5 mm² through-wiring
3 x 2,5 mm²
5 x 2,5 mm²

Order code

9462
9463
9464
9465

Light and presence sensor

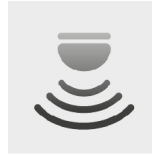

Please note:
This option can be supplied on request.

Suspension



Suspension Type "I" (x4)
Suspension Type "Y" (x2)

Order code

910002
910003

Microperforated panel



Microperforated panel

Order code

BM

Direct and indirect light

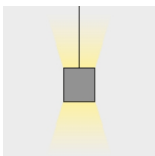

Direct and indirect light with 80:20 ratio

Order code

D/I

Emergency unit



Emergency unit 3 hours
Emergency unit 1 hour

Order code

K3
K1

Modules L, T and X



Module L
Module T
Module X

Order code

9908
9909
9910

Lamps as optional



Please note:
This option can be supplied on request.

Bespoke projects



Please note:
This option can be supplied on request.

We reserve the right to make technical changes without prior notice.
Electrical/Optical data are subjected to a tolerance of +/-10%.

DETAILS



Suspension Type "I"



Suspension Type "Y"

PHOTOMETRY

ANS Line 1x80W PM
Lamp: 1 x FC 80W/840 HO

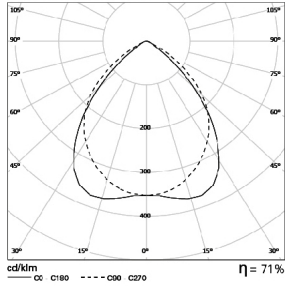

ANS Line 2x35W PB
Lamp: 2 x FH 35W/840 HE

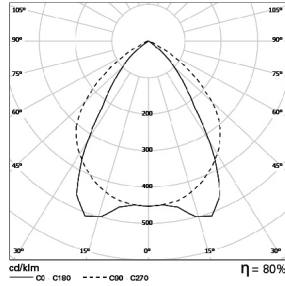

DIMENSIONS

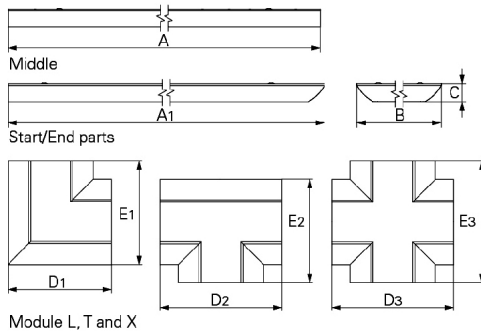

BODY CONFIG

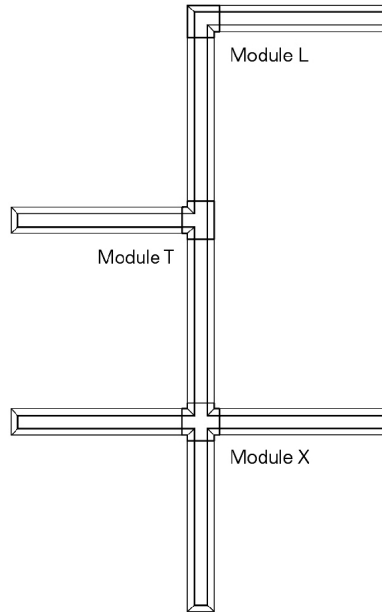

	Module L	Module T	Module X
	D1xE1 (mm)	D2xE2 (mm)	D3xE3 (mm)
1 lamp	249x249	292x242	292x292
2 lamps	425x425	474x425	474x474

TO SPECIFY:

Suspended T5(G5) luminaire in extruded aluminium profile for continuous line with polished/satin high output aluminium louvre. □ Direct/indirect version with 80:20 ratio. Optional light/presence sensor, direct/indirect version, dimmable versions and 1 or 3 hours emergency available – as Indelague ANS Line.

We reserve the right to make technical changes without prior notice.
Electrical/Optical data are subjected to a tolerance of +/-10%.