

Norms: EN 60598-1, EN 60598-2-2



d1,0mE

PRODUCT DESCRIPTION

Areas of Application: Commercial and Business areas, Public buildings, Housing, Offices, Hotel and Restaurant services, Art and Culture spaces.

Mounting: Ceiling recessed.

Light Distribution: Direct.

Light Source: LED or Halogen (G53) lamp or CDM-R111 (GX8.5) lamp.





Control Gear: Electronic equipment 220-240VAC-50/60Hz. 12V transformer included for G53.

Materials: Body: Steel sheet.





Surface Finish: Powder coated.







KUUT A1 - (Body order code 9006701000)

	LAMP*		W	BEAM 	AxBxC (mm)		Kg	ORDER CODE
	LED 12V	G53	10/15	24/40	173x173x157	155x155	1,8	90067.U112.I
	HAL 12V	G53	45/60	24/45	173x173x157	155x155	1,8	90067.U100.I
	CDM-R111	GX8.5	35	10/40	173x173x157	155x155	1,8	90067.A135.A
		GX8.5	70	10/40	173x173x157	155x155	1,8	90067.A170.A

KUUT A2 - (Body order code 9006702000)

	LAMP*		W	BEAM 	A1xB1xC (mm)		Kg	ORDER CODE
	LED 12V	G53	10/15	24/40	312x173x157	295x155	2,2	90067.U112.I
	HAL 12V	G53	45/60	24/45	312x173x157	295x155	2,2	90067.U100.I
	CDM-R111	GX8.5	35	10/40	312x173x157	295x155	2,2	90067.A135.A
		GX8.5	70	10/40	312x173x157	295x155	2,2	90067.A170.A



KUUT A3 - (Body order code 9006703000)

	LAMP*		W	BEAM 	A2xB2xC (mm)		Kg	ORDER CODE
	LED 12V	G53	10/15	24/40	452x173x157	435x155	2,9	90067.U112.I
	HAL 12V	G53	45/60	24/45	452x173x157	435x155	2,9	90067.U100.I
	CDM-R111	GX8.5	35	10/40	452x173x157	435x155	2,9	90067.A135.A
		GX8.5	70	10/40	452x173x157	435x155	2,9	90067.A170.A

* Lamp not included. | ** Changes applicable only to bezel
 Example code for order: 9006704000 (BODY ORDER CODE) + (4x)90067.U112.I (ORDER CODE) + W (COLOUR/FINISH)

We reserve the right to make technical changes without prior notice.
 Electrical/Optical data are subjected to a tolerance of +/-10%.

KUUT A4 - (Body order code 9006704000)

	LAMP*		W	BEAM \angle	A3xB3xC (mm)		Kg	ORDER CODE
	LED 12V	G53	10/15	24/40	320x320x157	303x303	3,5	90067.U112.I
	HAL 12V	G53	45/60	24/45	320x320x157	303x303	3,5	90067.U100.I
	CDM-R111	GX8.5	35	10/40	320x320x157	303x303	3,5	90067.A135.A
		GX8.5	70	10/40	320x320x157	303x303	3,5	90067.A170.A

Please note:
To order a complete product, please order body code plus order code.
Electronic transformer 35 - 105W (G53). We recommend PHILIPS lamps.

COLOUR / FINISH

Code	Description
W	White (RAL 9016) **
B	Black (RAL 9005) **
G	Grey (RAL 9006) **

OPTIONS

Code	Description
--	Lamps as optional..

DETAILS



Downlight detail

PHOTOMETRY

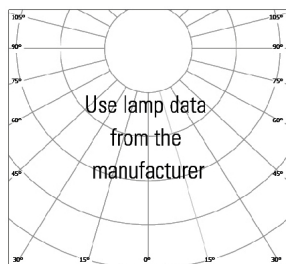

DIMENSIONS

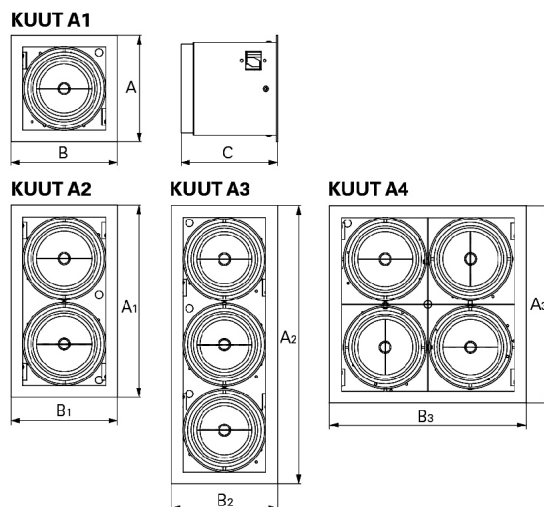

TO SPECIFY:

Recessed gimbal cluster luminaire built in steel sheet. Single, double, triple or four gimbal cluster per luminaire. Lamps to be ordered separately - as Roxo Lighting KUUT.

We reserve the right to make technical changes without prior notice.
Electrical/Optical data are subjected to a tolerance of +/-10%.