



Norms: EN 60598-1, EN 60598-2-2



d1,0mE

PRODUCT DESCRIPTION

Areas of Application: Commercial and Business areas, Public buildings, Housing, Offices, Hotel and Restaurant services, Art and Culture spaces.

Mounting: Ceiling recessed.

Light Distribution: Direct.



Light Source: LED or Halogen (G53) lamp or CDM-R111 (GX8.5) lamp.

Control Gear: Electronic equipment 220-240VAC-50/60Hz. 12V transformer included for G53.



Materials: Body: Steel sheet.

Surface Finish: Powder coated.



KUUT / T A1 - (Body order code 9012201000)

	LAMP*		W	BEAM ↘	AxBxC (mm)		Kg	ORDER CODE
	LED 12V	G53	10/15	24/40	151x150x158	153x152	1,8	90067.U112.I
	HAL 12V	G53	45/60	24/45	151x150x158	153x152	1,8	90067.U100.I
	CDM-R111	GX8.5	35	10/40	151x150x158	153x152	1,8	90067.A135.A
		GX8.5	70	10/40	151x150x158	153x152	1,8	90067.A170.A

KUUT / T A2 - (Body order code 9012202000)

	LAMP*		W	BEAM ↘	A1xB1xC (mm)		Kg	ORDER CODE
	LED 12V	G53	10/15	24/40	290x150x158	292x152	2,2	90067.U112.I
	HAL 12V	G53	45/60	24/45	290x150x158	292x152	2,2	90067.U100.I
	CDM-R111	GX8.5	35	10/40	290x150x158	292x152	2,2	90067.A135.A
		GX8.5	70	10/40	290x150x158	292x152	2,2	90067.A170.A

KUUT / T A3 - (Body order code 9012203000)



	LAMP*		W	BEAM ↘	A2xB2xC (mm)		Kg	ORDER CODE
	LED 12V	G53	10/15	24/40	430x150x158	432x152	2,9	90067.U112.I
	HAL 12V	G53	45/60	24/45	430x150x158	432x152	2,9	90067.U100.I
	CDM-R111	GX8.5	35	10/40	430x150x158	432x152	2,9	90067.A135.A
		GX8.5	70	10/40	430x150x158	432x152	2,9	90067.A170.A

* Lamp not included.

Example code for order: 9012204000 (BODY ORDER CODE) + (4x)90067.U112.I (ORDER CODE) + W (COLOUR/FINISH)

We reserve the right to make technical changes without prior notice. Electrical/Optical data are subjected to a tolerance of +/-10%.

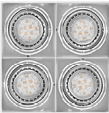
KUUT / T A4 - (Body order code 9012204000)

	LAMP*		W	BEAM \angle	A3xB3xC (mm)		Kg	ORDER CODE
	LED 12V	G53	10/15	24/40	298x298x158	300x300	3,5	90067.U112.I
	HAL 12V	G53	45/60	24/45	298x298x158	300x300	3,5	90067.U100.I
	CDM-R111	GX8.5	35	10/40	298x298x158	300x300	3,5	90067.A135.A
		GX8.5	70	10/40	298x298x158	300x300	3,5	90067.A170.A

Please note:

To order a complete product, please order body code plus order code.
Electronic transformer 35 - 105W (G53). We recommend PHILIPS lamps.

COLOUR / FINISH

Code	Description
W	White (RAL 9016) **
B	Black (RAL 9005) **
G	Grey (RAL 9006) **

OPTIONS

Code	Description
--	Lamps as optional..

DETAILS



Downlight detail

PHOTOMETRY

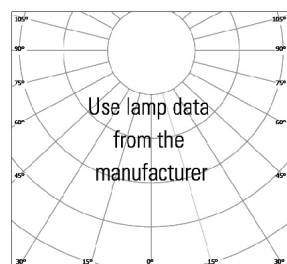

DIMENSIONS

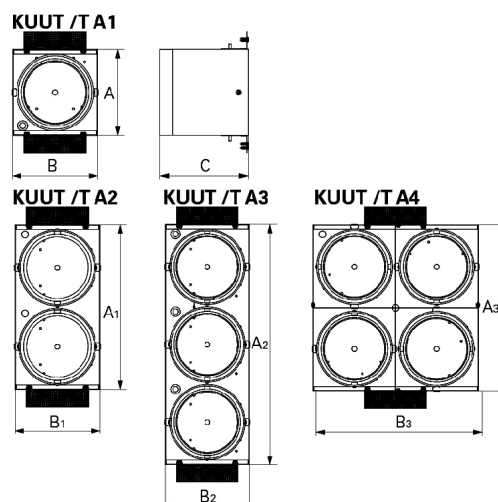

TO SPECIFY:

Recessed trimless gimbal cluster luminaire built in steel sheet. Single, double, triple or four gimbal cluster per luminaire. Lamps to be ordered separately - as Indelague KUUT / T.

We reserve the right to make technical changes without prior notice.
Electrical/Optical data are subjected to a tolerance of +/-10%.