

Norms: EN 60598-1, EN 60598-2-2



PRODUCT DESCRIPTION

Areas of Application: Commercial and Business areas, Public buildings, Housing, Offices, Hotel and Restaurant services, Art and Culture spaces.

Mounting: Ceiling recessed.

Light Distribution: Direct.

Light Source: T5 (G5) lamp.

Control Gear: Electronic equipment, 220-240VAC-50/60Hz.

Materials: Body: Extruded aluminium profile.

Surface Finish: Anodised in natural colour.

Fixing system: Brackets.

PB - Polished double parabolic louvre (middle)

LAMP*	W	η(%)	AxBxC (mm)	□	Kg	HF	DSI	DALI
	1x14**	73	585x77x80	585x70	1	90204.P114.A	90204.P114.C	90204.P114.D
	1x21	77	885x77x80	885x70	1	90204.P121.A	90204.P121.C	90204.P121.D
	1x24**	79	585x77x80	585x70	1	90204.P124.A	90204.P124.C	90204.P124.D
	1x28	77	1185x77x80	1185x70	2	90204.P128.A	90204.P128.C	90204.P128.D
	1x35	75	1485x77x80	1485x70	3	90204.P135.A	90204.P135.C	90204.P135.D
	1x39	74	885x77x80	885x70	1	90204.P139.A	90204.P139.C	90204.P139.D
	1x49	75	1485x77x80	1485x70	3	90204.P149.A	90204.P149.C	90204.P149.D
	1x54	76	1185x77x80	1185x70	2	90204.P154.A	90204.P154.C	90204.P154.D
	1x80	84	1485x77x80	1485x70	3	90204.P180.A	90204.P180.C	90204.P180.D

Add suffix to order: Start - 00000.0000.0.0049 End - 00000.0000.0.0050

BLINE - Opal polycarbonate diffuser (middle)

LAMP*	W	η(%)	AxBxC (mm)	□	Kg	HF	DSI	DALI
	1x14**	51	485x77x80	485x70	1	90200.P114.A	90200.P114.C	90200.P114.D
	1x21	54	785x77x80	785x70	1	90200.P121.A	90200.P121.C	90200.P121.D
	1x24**	53	485x77x80	485x70	1	90200.P124.A	90200.P124.C	90200.P124.D
	1x28	56	1085x77x80	1085x70	2	90200.P128.A	90200.P128.C	90200.P128.D
	1x35	55	1385x77x80	1385x70	3,4	90200.P135.A	90200.P135.C	90200.P135.D
	1x39	52	785x77x80	785x70	1,9	90200.P139.A	90200.P139.C	90200.P139.D
	1x49	53	1385x77x80	1385x70	3,4	90200.P149.A	90200.P149.C	90200.P149.D
	1x54	57	1085x77x80	1085x70	2,7	90200.P154.A	90200.P154.C	90200.P154.D
	1x80	60	1385x77x80	1385x70	3,4	90200.P180.A	90200.P180.C	90200.P180.D

Add suffix to order: Start - 00000.0000.0.0049 End - 00000.0000.0.0050

Please note:

To complete a line, Start kit will be necessary. Please order separately.
 Recessed dimensions without end caps, add 8mm to complete the line.
 **14/24W version only available as end part of the line.







*Lamp not included.
 Example code for order: 90204.P128.D.0049 (START) + 90204.P128.D (MIDDLE) + 90204.P124.D.0050 (END) + 9020700 + (2x) 9463 + (2x) 965200 + (2x) 930500 (OPTIONS)

We reserve the right to make technical changes without prior notice.
 Electrical/Optical data are subjected to a tolerance of +/-10%.

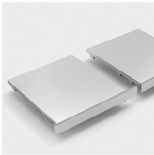
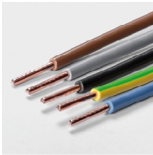
COLOUR / FINISH

Code	Description
W	White (RAL 9016)
B	Black (RAL 9005)

OPTIONS

Start kit		Order code	Through-wiring		Order code
	Start kit	920700		1,5 mm2 through-wiring	
	• Two end caps included.			3 x 1,5 mm2	9462
		5 x 1,5 mm2		9463	
		7 x 1,5 mm2		9466	
		2,5 mm2 through-wiring			
		3 x 2,5 mm2		9464	
		5 x 2,5 mm2	9465		
		7 x 2,5 mm2	9467		
Connectors			Body connector KIT		
	KIT 7-pole WAGO (male and female)	Order code 965200		Body connector	Order code 930500
	Connector 7-pole WAGO male	965201		• Galvanised connector, includes screws.	
	Connector 7-pole WAGO female	965202			
Light corners			Blank parts		
	Horizontal corner	Order code		1,5m length	Order code 991300
	14w (530x530mm)	90200.H.214		3m length	991301
	24w (530x530mm)	90200.H.224		• Includes empty aluminium body and blanking cover.	
	Vertical corner				
	14w (535x535mm)	90200.V.214			
	24w (535x535mm)	90200.V.224			
	• T5 (G5) light corner with not dimmable ballast and BLINE polycarbonate diffuser included.				
Emergency unit			Bespoke projects		
	Emergency unit 3 hours	Order code K3		Please note:	
	Emergency unit 1 hour	K1		This option can be supplied on request.	

DETAILS



Clip-in polycarbonate diffuser

Clip-in aluminium louvre

We reserve the right to make technical changes without prior notice. Electrical/Optical data are subjected to a tolerance of +/-10%.

PHOTOMETRY

REBA 65/E Line 1x80W BLINE
Lamp: 1 x 80W/840 H0

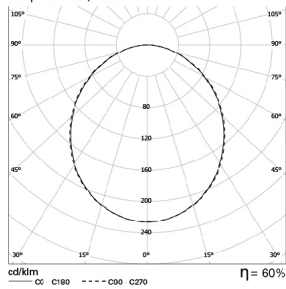

REBA 65/E Line 1x80W PB
Lamp: 1 x 80W/840 H0

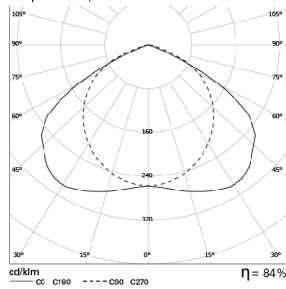

DIMENSIONS

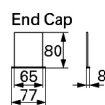
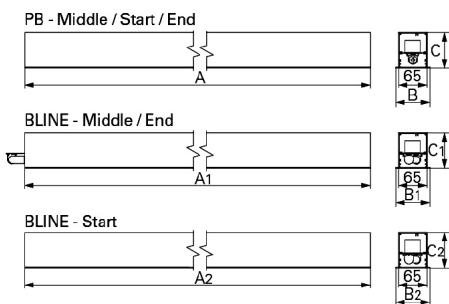

 For this version the cutting width is 70 mm.



BLINE - Start

W	AzxBxCz (mm)	
1x14	585x77x80	585x70
1x21	885x77x80	885x70
1x24	585x77x80	585x70
1x28	1185x77x80	1185x70
1x35	1485x77x80	1485x70
1x39	885x77x80	885x70
1x49	1485x77x80	1485x70
1x54	1185x77x80	1185x70
1x80	1485x77x80	1485x70

Please note: Recessed dimensions without end caps, add 8mm to complete the line.

TO SPECIFY:

Linear recessed T5(G5) luminaire for continuous line with 77mm width extruded aluminium profile, anodised in natural colour. Polycarbonate end caps and PB louvre or BLINE polycarbonate diffuser. Available with HF, DSI or DALI control gear. Optional light corners and 1 or 3 hours emergency – as Roxo Lighting REBA 65 /E Line.

We reserve the right to make technical changes without prior notice. Electrical/Optical data are subjected to a tolerance of +/-10%.