

stella  
66









INDELAGUE GROUP

**INDELAGUE** ROXO lighting



# OVERVIEW

	STELLA 66 RANGE
	 <p>STELLA 66</p>
Type of Application	
Light Distribution	
Dimensions*	660x101x101 mm 1277x101x101 mm 1573x101x101 mm 660x145x101 mm 1277x145x101 mm 1573x145x101 mm
Optical System	DCO 
Colour Temperature	3000K 4000K
Finishes	Body:  Grey      Gear Tray:  White
IP / IK Protection	IP66 IK08
IP68 Connector	✓
Light and Presence Sensor	✓
Stainless Steel Fixing System	✓
Emergency Unit**	1 or 3 Hours

\* Indicative dimensions.  
For dimension details,  
please check our website  
or current catalogue.

\*\* Emergency unit is not  
available for 660mm  
versions.

# OPTICAL SYSTEM

D C O

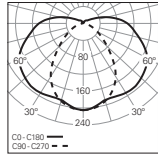
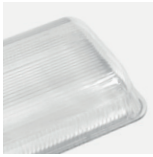

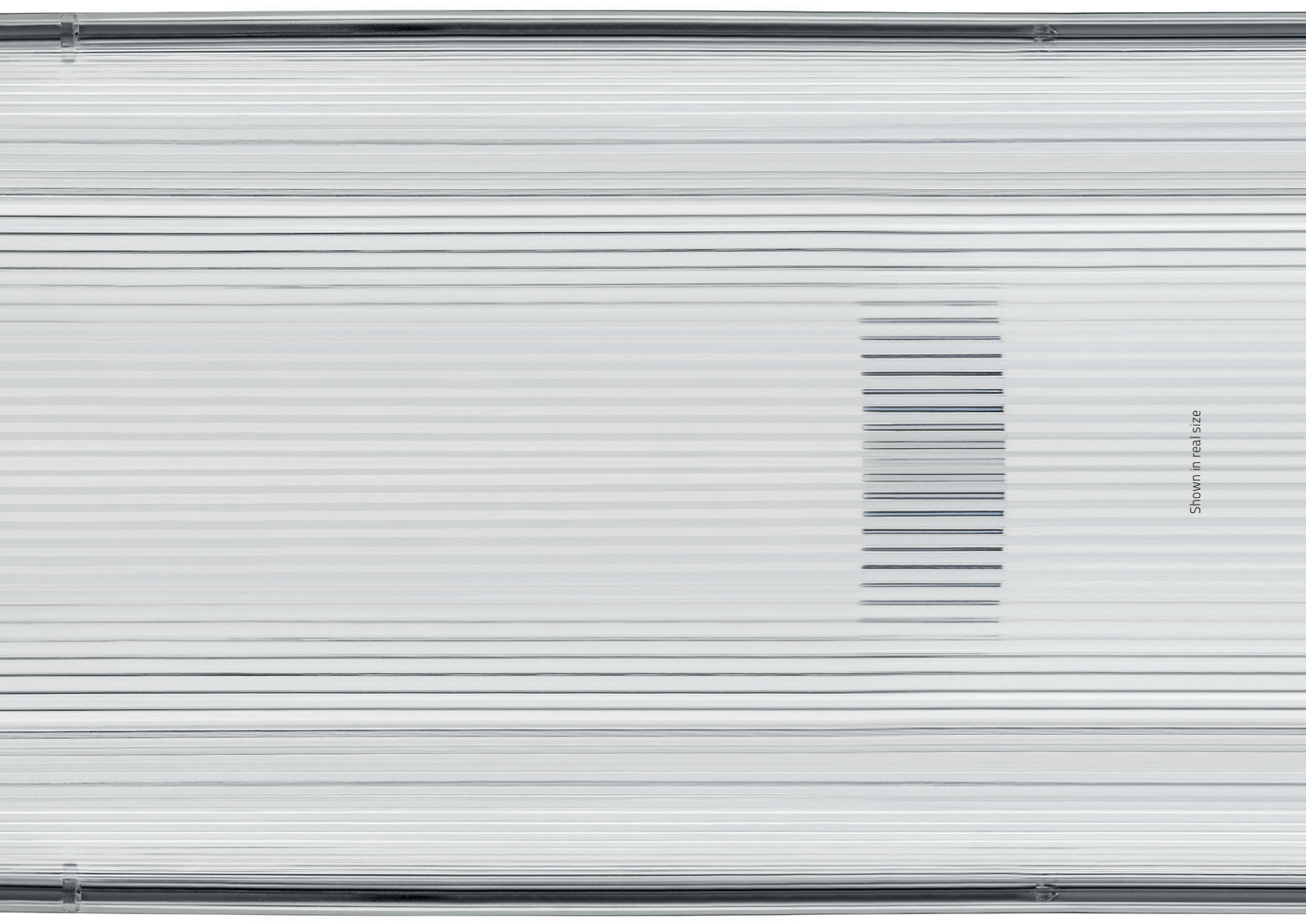

Shown in real size

**STELLA 66**  
RANGE



**STELLA 66**  
Suspended

---

STELLA 66 RANGE

---



SURFACE MOUNTED



SUSPENDED



WALL MOUNTED

---



**STELLA 66**  
Surface mounted



**STELLA 66**  
Wall mounted

---

AVAILABLE  
SIZES

---



101x101 mm

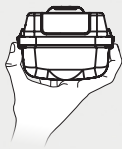

145x101 mm







BUILT TO RESIST



Shown in real size



Shown in real size

# FEATURES

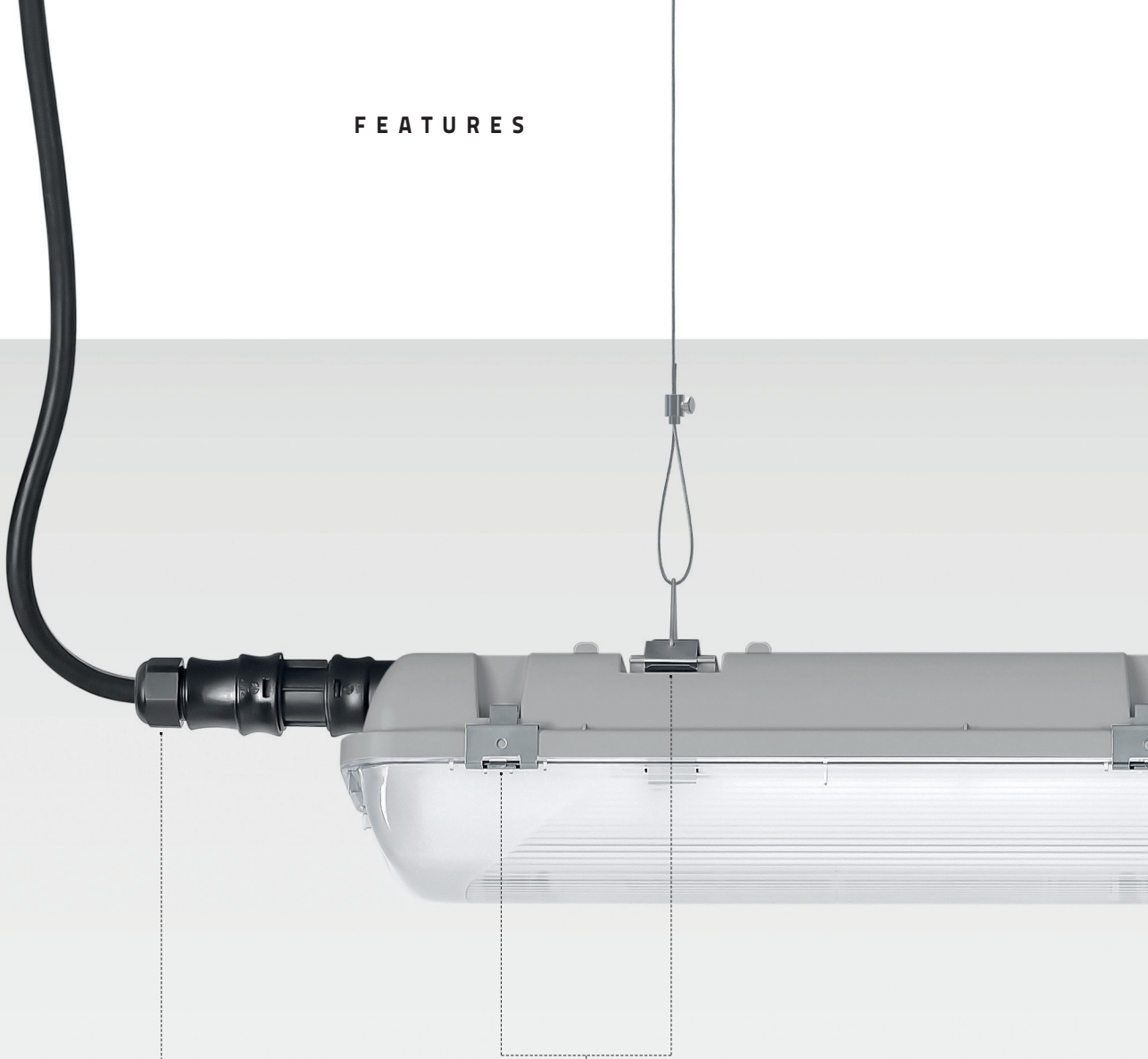

IP68  
CONNECTOR



STAINLESS  
STEEL  
FIXING  
CLIPS  
AND  
BRACKETS



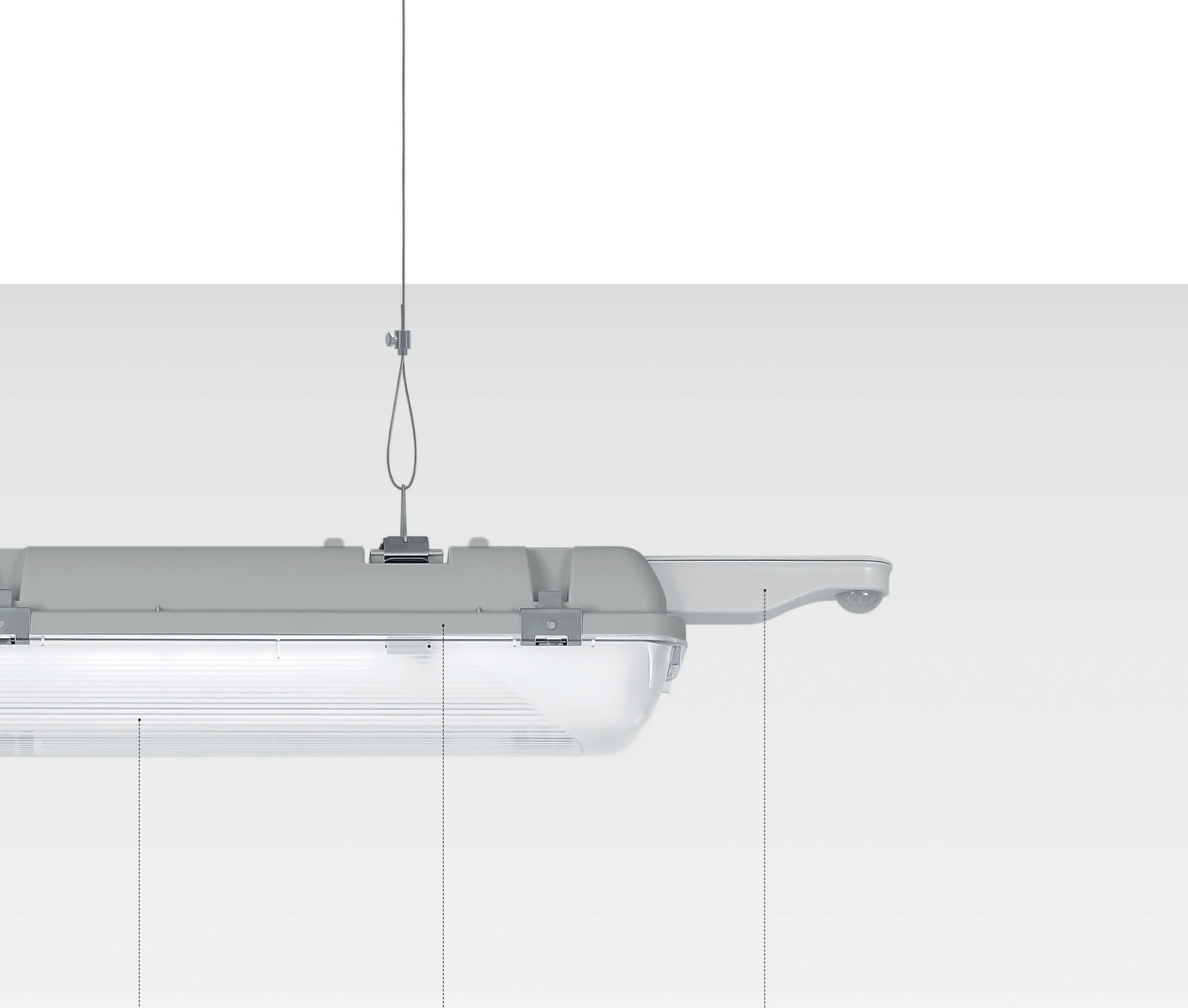

DCO  
DIFFUSER

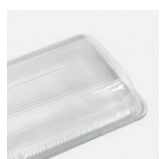

INJECTED  
POLYCARBONATE  
AND  
NATURAL  
SILICONE  
GASKET

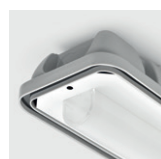

LIGHT  
AND  
PRESENCE  
SENSOR







MINIMALISM AND TECHNOLOGY



Version with 1 line of LED's



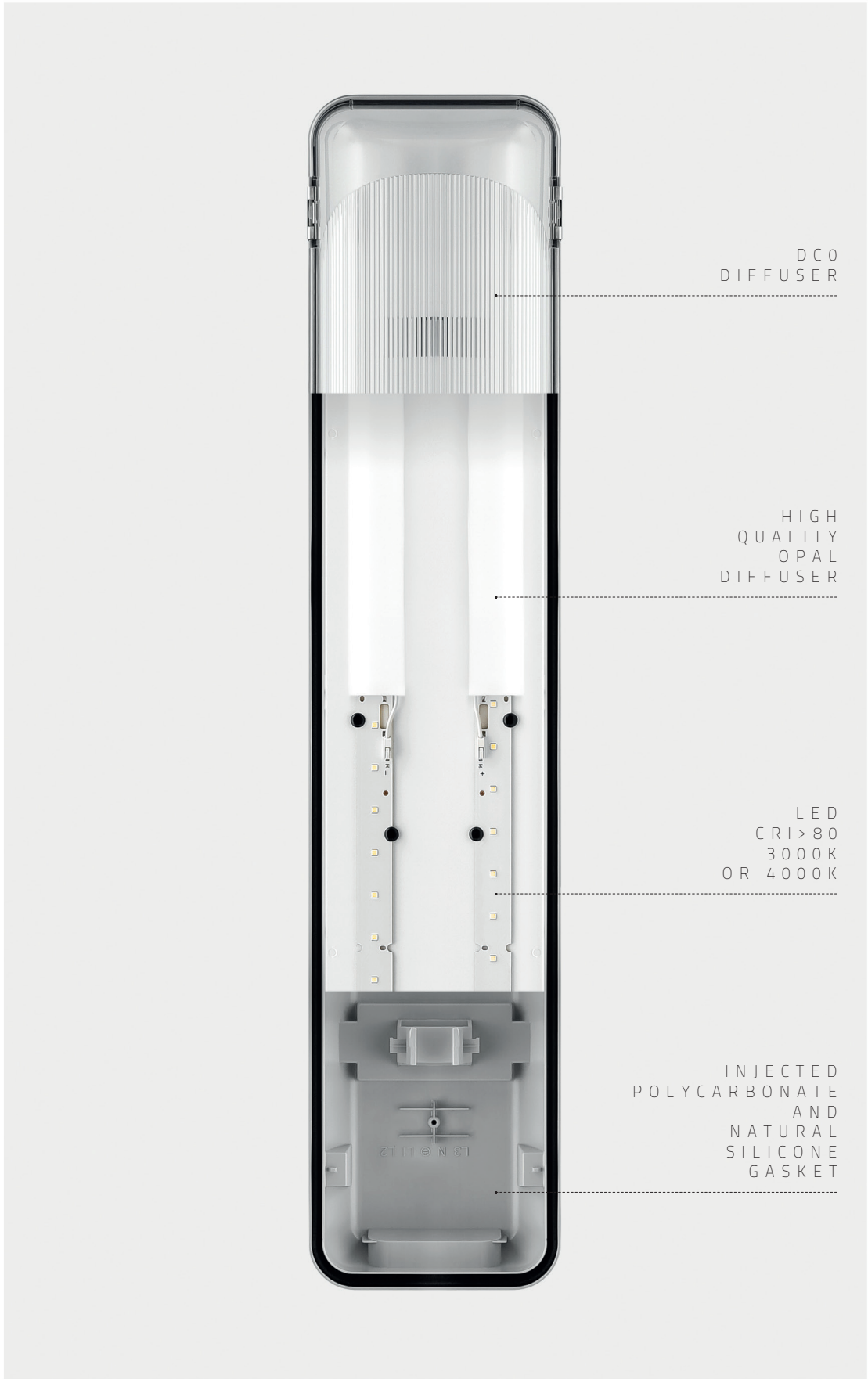

DCO  
DIFFUSER

HIGH  
QUALITY  
OPAL  
DIFFUSER

LED  
CRI > 80  
3000K  
OR 4000K

INJECTED  
POLYCARBONATE  
AND  
NATURAL  
SILICONE  
GASKET

Version with 2 lines of LED's

## 6 DIFFERENT SIZES

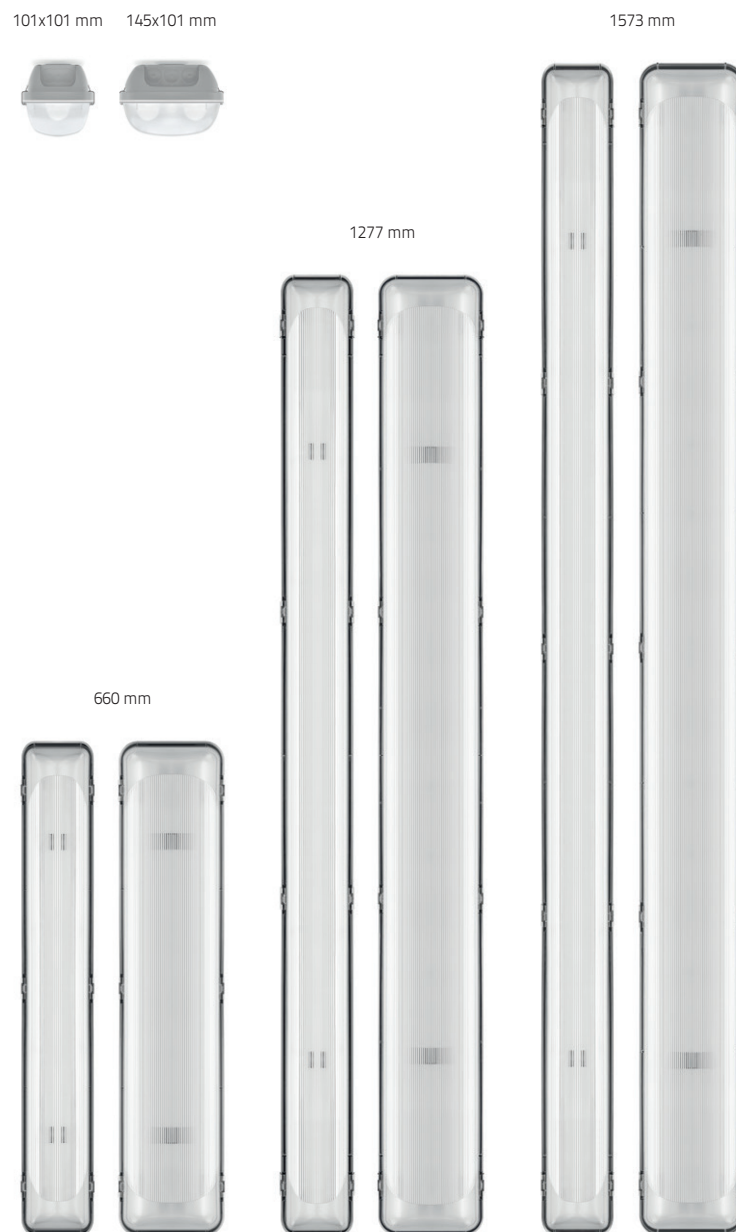



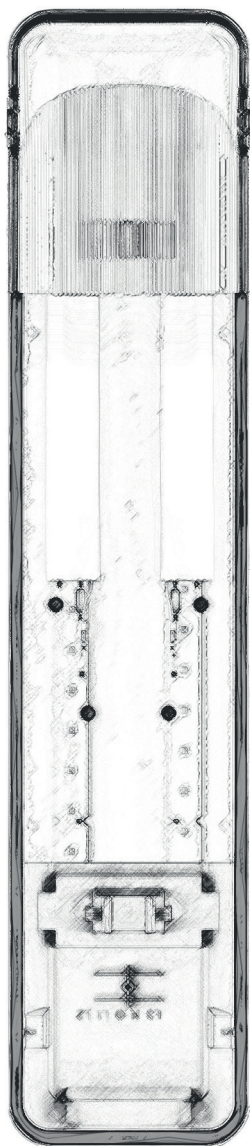

## INDELAGUE GROUP

### HEADQUARTERS

INDÚSTRIA ELÉTRICA DE ÁGUEDA S.A.  
Rua da Mina 465 | Covão  
Zona industrial EN1 Norte  
Apartado 106 / 3754-909  
3750-792 Trofa  
ÁGUEDA | PORTUGAL  
GPS: 40°36'5.84"N 8°27'4.38"W  
T. +351 234 612 310 | F. +351 234 624 058  
indelague@indelague.pt  
WWW.INDELAGUE.COM

### UNITED KINGDOM

ROXO LIGHTING LIMITED  
roxo.london@roxolighting.com  
WWW.ROXOLIGHTING.COM

### SPAIN

INDELAGUE ESPAÑA, S.L.  
Avenida del Ejército, n° 8 - 1° C  
C.P. 15006 | A CORUÑA | ESPAÑA  
comercial@indelague.com  
WWW.INDELAGUE.COM

All data contained in this brochure does not constitute any commitment to INDELAGUE - Indústria Eléctrica de Águeda, S.A. . The company itself, reserves the right to change or modify any information stated without prior notice. The reproduction of this brochure or any part of it is prohibited. Electric/Optical data are subject to an initial tolerance of +/- 10%. Tolerance of colour temperature: +/- 150 K. Unless stated otherwise, the technical data represent rated values for an ambient temperature of 25°C.

Cofinanciado por:

