

Stella 66







GROUPE INDELAGUE

INDELAGUE ROXO lighting



LA GAMME

	GAMME STELLA 66
	 <p>STELLA 66</p>
Type d'Application	
Distribution de Lumière	
Dimensions*	660x101x101 mm 1277x101x101 mm 1573x101x101 mm 660x145x101 mm 1277x145x101 mm 1573x145x101 mm
Système Optique	DCO 
Température de Couleur	3000K 4000K
Finitions	Corps: ● Gris Réglette Intérieure: ○ Blanc
Protection IP / IK	IP66 IK08
Connecteur IP68	✓
Capteur de Lumière et Présence	✓
Système de Fixation en Inox	✓
Unité de Secours**	1 ou 3 Heures

* Dimensions indicatives.
Pour les dimensions détaillées, veuillez consulter notre site Web ou notre catalogue.

** L'unité de secours n'est pas disponible pour les versions 660mm.

SYSTEME OPTIQUE

D C O

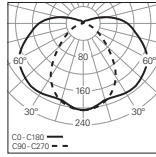
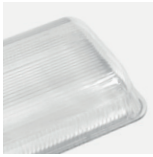

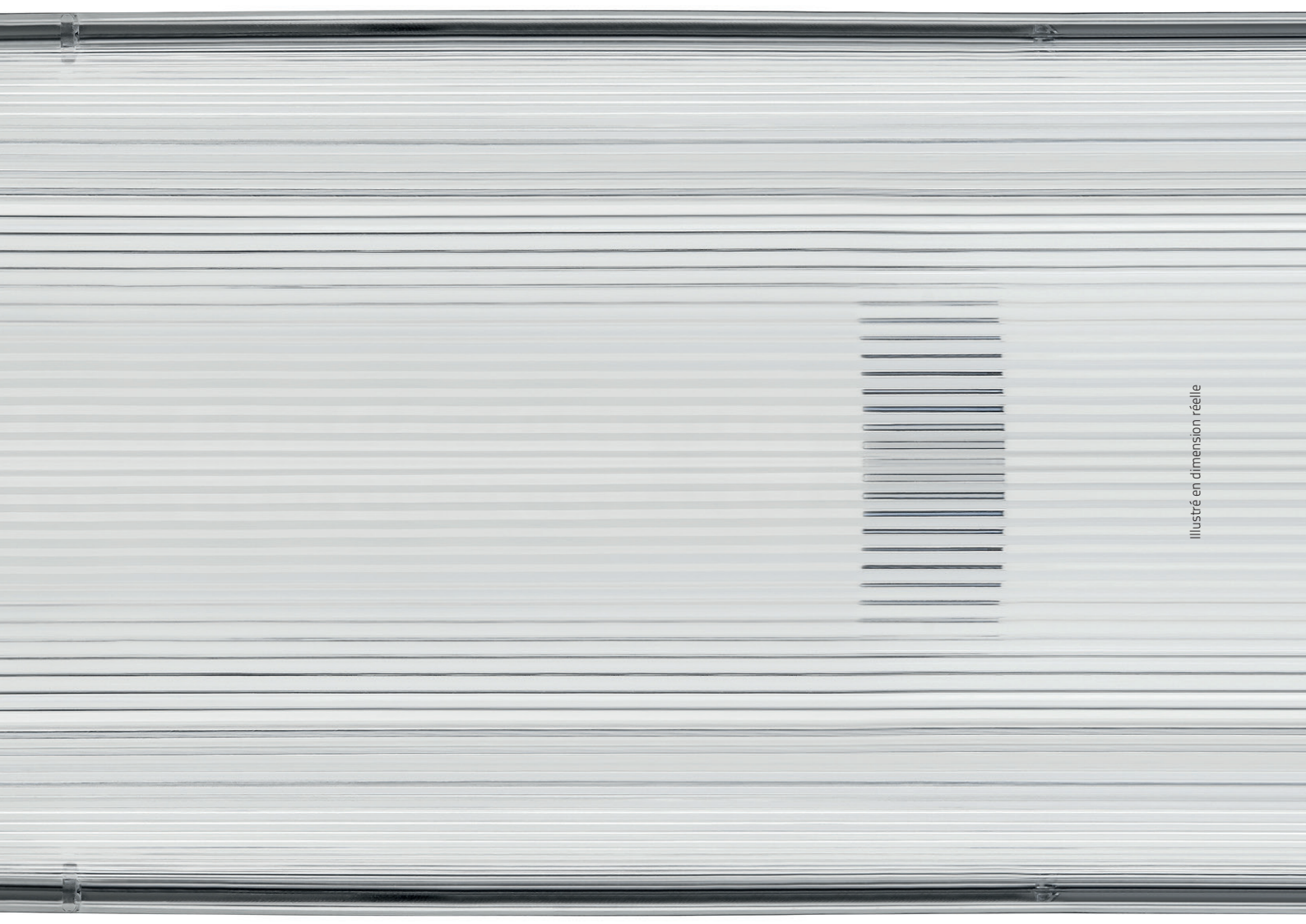

Illustré en dimension réelle

GAMME
STELLA 66



STELLA 66
Suspendu

GAMME STELLA 66



SAILLIE



SUSPENDU



APPLIQUE



STELLA 66
Saillie



STELLA 66
Applique

DIMENSIONS
DISPONIBLES



101x101 mm

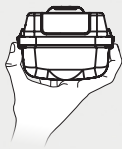

145x101 mm





CONSTRUIT POUR RESISTER



Illustré en dimension réelle



Illustré en dimension réelle

CARACTERISTIQUES

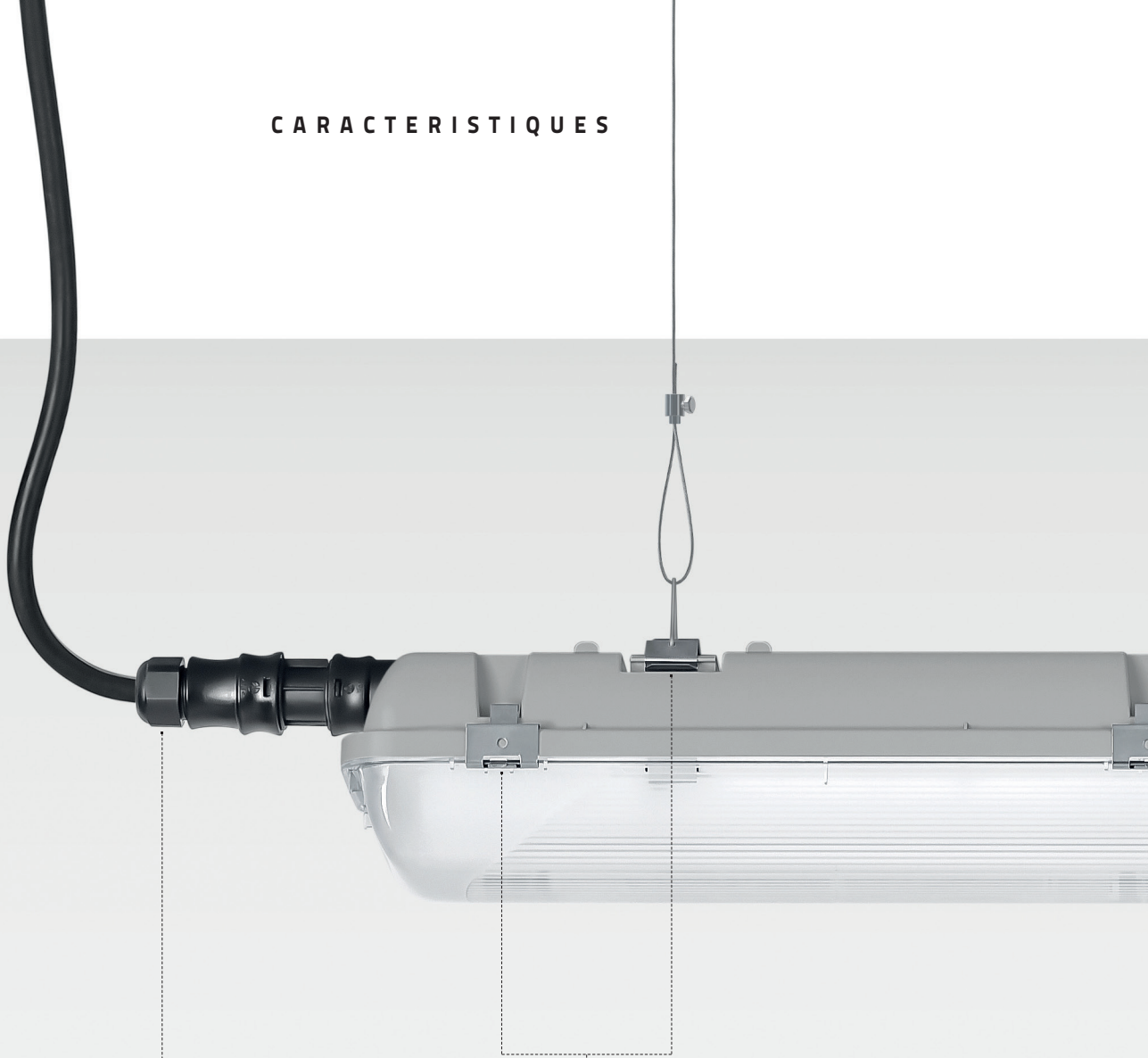

CONNECTEUR
IP68



CLIPS ET
PINCES DE
FIXATION
EN INOX



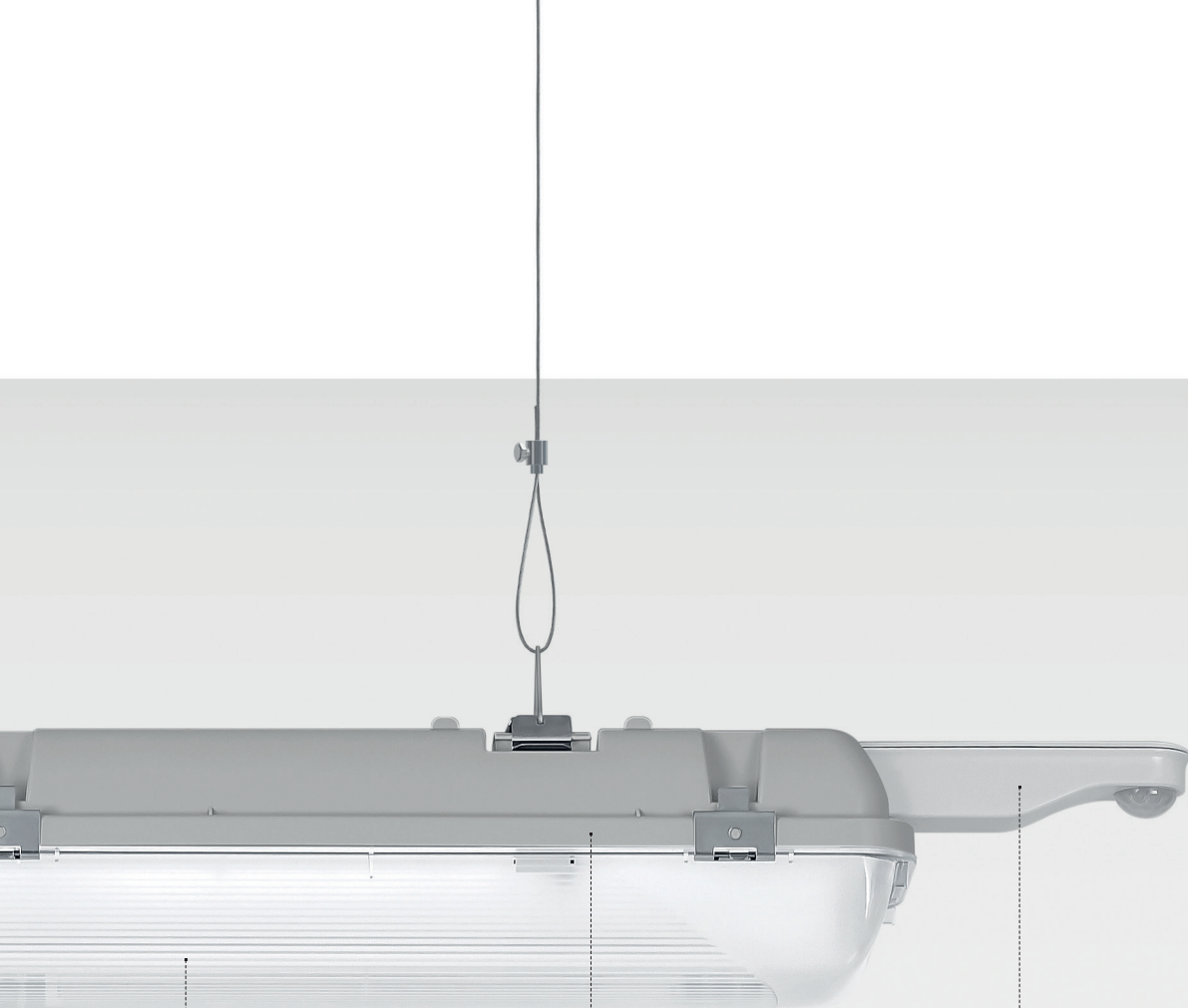

DIFFUSEUR
DCO

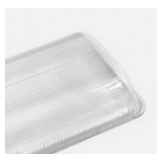

POLYCARBONATE
INJECTE
ET JOINT
D'ETANCHEITE
EN SILICONE

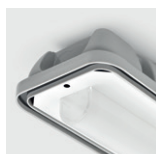

CAPTEUR DE
LUMIERE ET
PRESENCE







TECHNOLOGIE ET MINIMALISME



Version avec 1 rangée de LED's

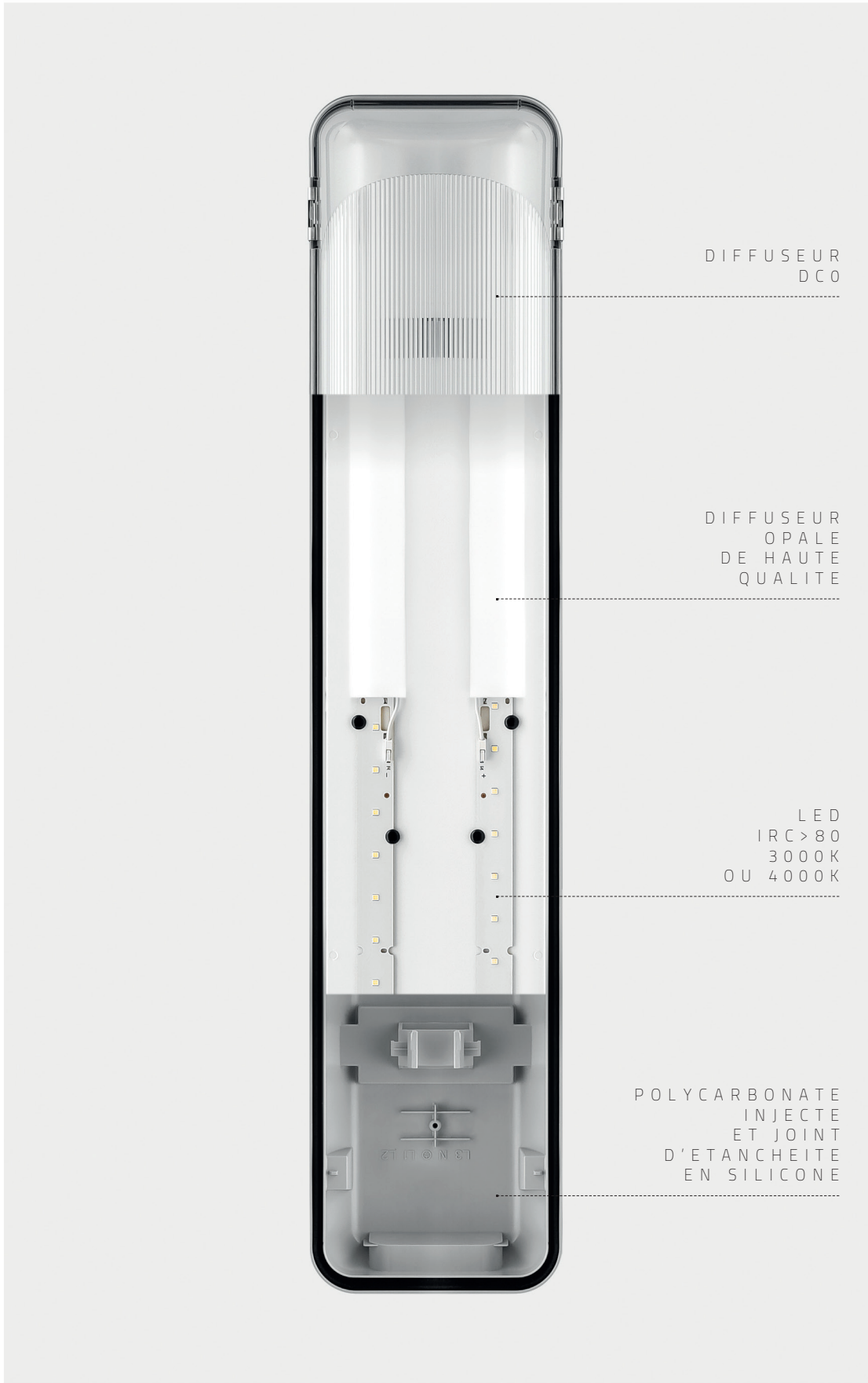

Version avec 2 rangées de LED's

6 TAILLES DISPONIBLES

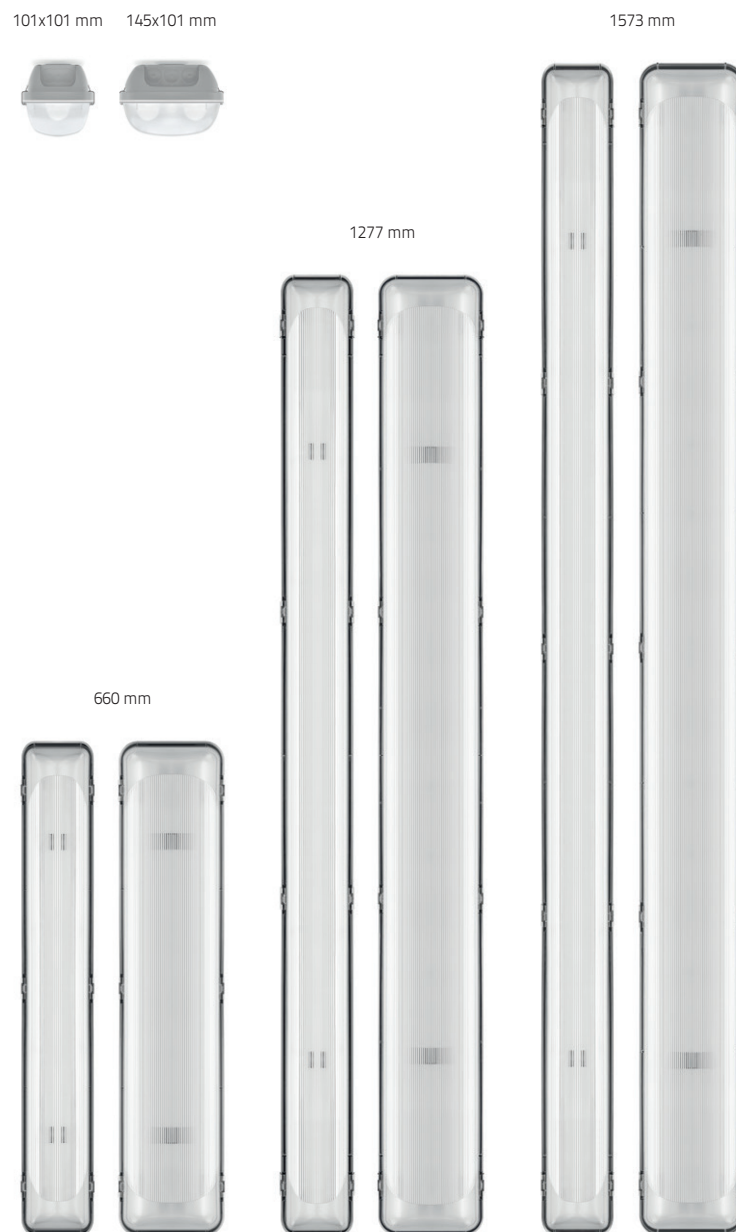



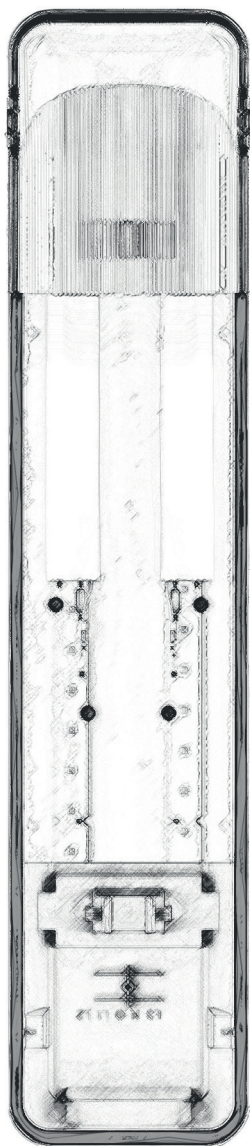

GRUPE INDELAGUE

SIEGE

INDÚSTRIA ELÉTRICA DE ÁGUEDA S.A.
Rua da Mina 465 | Covão
Zona industrial EN1 Norte
Apartado 106 / 3754-909
3750-792 Trofa
ÁGUEDA | PORTUGAL
GPS. 40°36'5.84"N 8°27'4.38"W
T. +351 234 612 310 | F. +351 234 624 058
indelague@indelague.pt
WWW.INDELAGUE.COM

ROYAUME-UNI

ROXO LIGHTING LIMITED
roxo.london@roxolighting.com
WWW.ROXOLIGHTING.COM

ESPAGNE

INDELAGUE ESPAÑA, S.L.
Avenida del Ejército, n° 8 - 1°C
C.P. 15006 | A CORUÑA | ESPAÑA
comercial@indelague.com
WWW.INDELAGUE.COM

Toutes les données contenues dans cette brochure ne constituent pas un engagement pour INDELAGUE - Indústria Eléctrica de Águeda, SA. La société se réserve le droit de changer ou de modifier toute information sans préavis. La reproduction de cette brochure ou une partie de celui-ci est interdite. Données électriques/optiques = +/-10%. Température de couleur sous réserve de tolérance de +/- 150K, à moins que se soit clairement spécifié. Toutes les valeurs sont valables pour une température ambiante de 25°C.

Cofinanciado por:

