



Norms: EN 60598-1, EN 60598-2-1



PRODUCT DESCRIPTION

Areas of Application: Commercial and Business areas, Public buildings, Offices, Schools, Corridors.

Mounting: Surface/Suspended.

Light Distribution: Direct.

Control Gear: Electronic equipment, 220-240VAC-50/60Hz.

Materials: Body: Steel sheet.

Surface Finish: Powder coated in white matt (RAL9016).

PB - Polished double parabolic louvre (middle)



LAMP*	UGR	W	Lm/W	η(%)	AxBxC (mm)	Kg	HF	DSI	DALI
	≤19	1x14	56	78	597x203x62	2,7	9R3V.114.80.A4	9R3V.114.80.84	9R3V.114.80.74
	≤19	1x24	60	86	597x203x62	2,7	9R3V.124.80.A4	9R3V.124.80.84	9R3V.124.80.74
	≤19	1x28	69	81	1197x203x62	3,5	9R3V.128.80.A4	9R3V.128.80.84	9R3V.128.80.74
	≤19	1x35	70	80	1497x203x62	4,3	9R3V.135.80.A4	9R3V.135.80.84	9R3V.135.80.74
	≤19	1x49	68	82	1497x203x62	4,3	9R3V.149.80.A4	9R3V.149.80.84	9R3V.149.80.74
	≤22	1x54	64	82	1197x203x62	3,5	9R3V.154.80.A4	9R3V.154.80.84	9R3V.154.80.74
	≤22	1x80	60	83	1497x203x62	4,3	9R3V.180.80.A4	9R3V.180.80.84	9R3V.180.80.74
	≤22	2x14	58	78	597x203x62	2,7	9R3V.214.80.A4	9R3V.214.80.84	9R3V.214.80.74
	≤22	2x24	55	77	597x203x62	2,7	9R3V.224.80.A4	9R3V.224.80.84	9R3V.224.80.74
	≤22	2x28	66	76	1197x203x62	3,5	9R3V.228.80.A4	9R3V.228.80.84	9R3V.228.80.74
	≤22	2x35	66	76	1497x203x62	4,3	9R3V.235.80.A4	9R3V.235.80.84	9R3V.235.80.74
	≤22	2x49	65	80	1497x203x62	4,3	9R3V.249.80.A4	9R3V.249.80.84	9R3V.249.80.74
	≤22	2x54	62	79	1197x203x62	3,5	9R3V.254.80.A4	9R3V.254.80.84	9R3V.254.80.74
	≤25	2x80	60	84	1497x203x62	4,3	9R3V.280.80.A4	9R3V.280.80.84	9R3V.280.80.74

* Lamp not included.
Example code for order: (6x) 9R3V.228.80.74 (DALI) + 920300 + (5x) 9465 + (6x) 910003 (OPTIONS)

We reserve the right to make technical changes without prior notice.
Electrical/Optical data are subjected to a tolerance of +/-10%.

PM - Satin double parabolic louvre (middle)



LAMP*	UGR	W	Lm/W	η(%)	AxBxC (mm)	Kg	HF	DSI	DALI
 T5	≤19	1x14	51	71	597x203x62	2,7	9R3V.114.93.A4	9R3V.114.93.84	9R3V.114.93.74
	≤19	1x24	52	74	597x203x62	2,7	9R3V.124.93.A4	9R3V.124.93.84	9R3V.124.93.74
	≤19	1x28	63	74	1197x203x62	3,5	9R3V.128.93.A4	9R3V.128.93.84	9R3V.128.93.74
	≤19	1x35	64	73	1497x203x62	4,3	9R3V.135.93.A4	9R3V.135.93.84	9R3V.135.93.74
	≤22	1x49	62	75	1497x203x62	4,3	9R3V.149.93.A4	9R3V.149.93.84	9R3V.149.93.74
	≤19	1x54	60	76	1197x203x62	3,5	9R3V.154.93.A4	9R3V.154.93.84	9R3V.154.93.74
	≤22	1x80	54	75	1497x203x62	4,3	9R3V.180.93.A4	9R3V.180.93.84	9R3V.180.93.74
	≤19	2x14	55	73	597x203x62	2,7	9R3V.214.93.A4	9R3V.214.93.84	9R3V.214.93.74
	≤22	2x24	52	71	597x203x62	2,7	9R3V.224.93.A4	9R3V.224.93.84	9R3V.224.93.74
	≤22	2x28	61	70	1197x203x62	3,5	9R3V.228.93.A4	9R3V.228.93.84	9R3V.228.93.74
	≤22	2x35	60	79	1497x203x62	4,3	9R3V.235.93.A4	9R3V.235.93.84	9R3V.235.93.74
	≤22	2x49	58	71	1497x203x62	4,3	9R3V.249.93.A4	9R3V.249.93.84	9R3V.249.93.74
	≤22	2x54	57	72	1197x203x62	3,5	9R3V.254.93.A4	9R3V.254.93.84	9R3V.254.93.74
	≤22	2x80	52	72	1497x203x62	4,3	9R3V.280.93.A4	9R3V.280.93.84	9R3V.280.93.74

OPTIONS

Start Kit



Start Kit
• 2 end caps and one cable lock, includes screws.

Order code
920300

Through-wiring

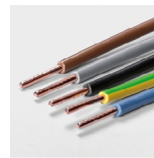

1,5 mm² through-wiring
3 x 1,5 mm²
5 x 1,5 mm²
2,5 mm² through-wiring
3 x 2,5 mm²
5 x 2,5 mm²

Order code
9462
9463
9464
9465

Light and presence sensor

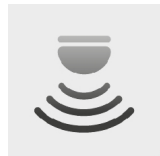

Please note:
This option can be supplied on request.

Suspension



Suspension Type "I" (x4)
Suspension Type "Y" (x2)

Order code
910002
910003

Emergency unit



Emergency unit 3 hours
Emergency unit 1 hour

Order code
K3
K1

Direct and indirect light

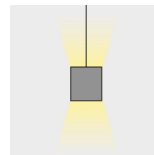

Direct and indirect light with 80:20 ratio

Order code
D/I

Modules L, T and X



Module L
Module T
Module X

Order code
990700
990701
990702

Lamps as optional



Please note:
This option can be supplied on request.

We reserve the right to make technical changes without prior notice.
Electrical/Optical data are subjected to a tolerance of +/-10%.

Bespoke projects



Please note:
This option can be supplied on request.

DETAILS



Suspension Type "Y"



Suspension Type "I"



End cap for light and presence sensor

PHOTOMETRY

TLU Line 2x30W PB
Lamp: 2 x 80W/840 HO

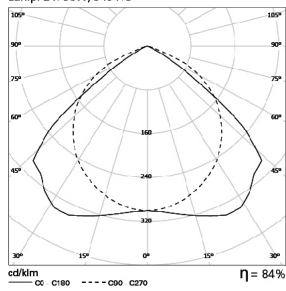

TLU Line 2x30W PM
Lamp: 2 x 80W/840 HO

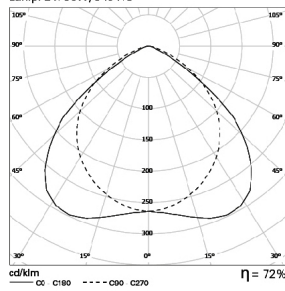

DIMENSIONS

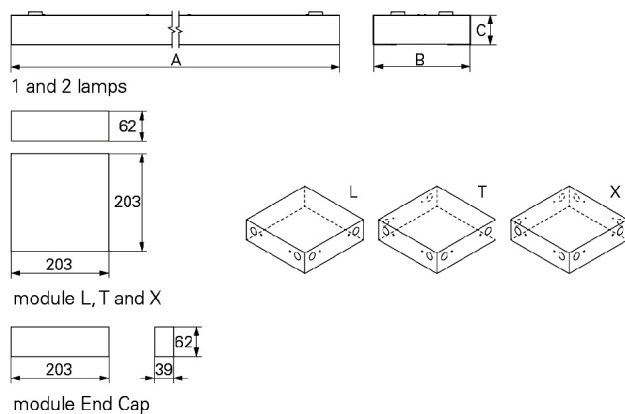

BODY CONFIG

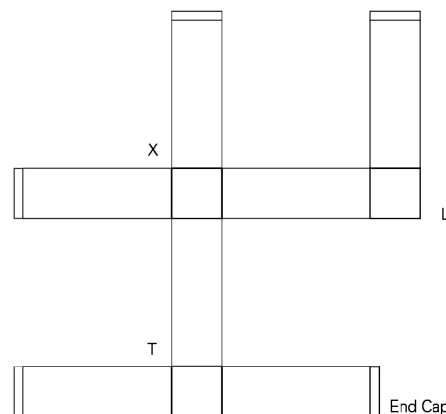

TO SPECIFY:

Suspended T5(G5) luminaire for continuous line with polished/satin high output aluminium louvre. Direct/indirect version with 80:20 ratio. Optional light/presence sensor, direct/indirect version, dimmable versions and 1 or 3 hours emergency available – as Roxo Lighting TLU Line.

We reserve the right to make technical changes without prior notice. Electrical/Optical data are subjected to a tolerance of +/-10%.